



Vehicle History Report™

US \$44.99

2015 LAND ROVER RANGE ROVER EVOQUE PURE PLUS

VIN: SALVP2BG7FH053269
4 DOOR WAGON/SPORT
UTILITY
2.0L I4 F DOHC 16V
GASOLINE
ALL WHEEL DRIVE

Branded Title: Salvage

17 Service history records

3 Previous owners

Types of owners: Corporate, Personal

Last owned in New York

101,600 Last reported odometer reading

This CARFAX Vehicle History Report is based only on information supplied to CARFAX and available as of 7/24/24 at 11:49:09 AM (CDT). Other information about this vehicle, including problems, may not have been reported to CARFAX. Use this report as one important tool, along with a vehicle inspection and test drive, to make a better decision about your next used car.

Accident / Damage History

Not all accidents / issues are reported to CARFAX

Event 1

02/24/2016

Damage reported: minor damage

[View More Details >](#)

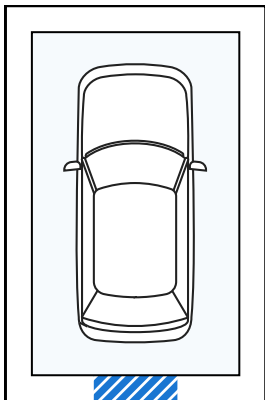
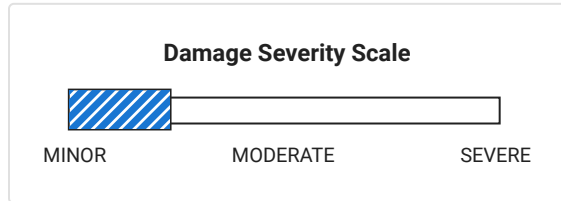

Event 2

11/09/2020

Damage reported: minor damage

[View More Details >](#)

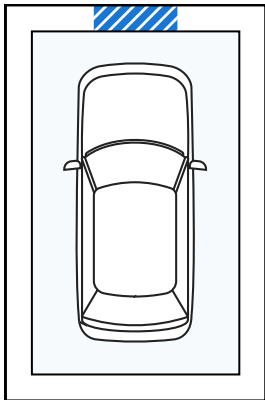
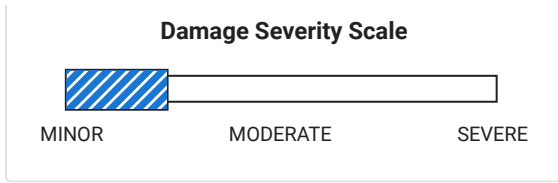



Event 3

06/08/2024

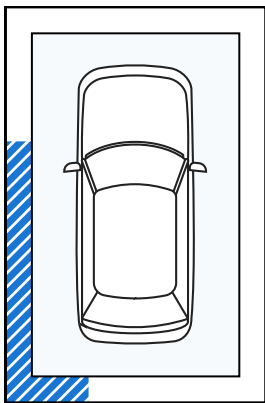
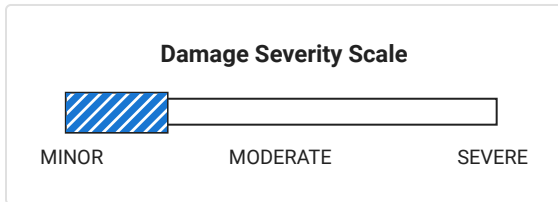

Accident reported: minor damage with another motor vehicle

[View More Details >](#)



 Additional History Not all accidents / issues are reported to CARFAX	Owner 1	Owner 2	Owner 3
Total Loss No total loss reported to CARFAX.	✓ No Issues Reported	✓ No Issues Reported	✓ No Issues Reported
Structural Damage CARFAX recommends that you have this vehicle inspected by a collision repair specialist.	✓ No Issues Reported	✓ No Issues Reported	✓ No Issues Reported
Airbag Deployment No airbag deployment reported to CARFAX.	✓ No Issues Reported	✓ No Issues Reported	✓ No Issues Reported

Odometer Check No indication of an odometer rollback.	<input checked="" type="checkbox"/> No Issues Indicated	<input checked="" type="checkbox"/> No Issues Indicated	<input checked="" type="checkbox"/> No Issues Indicated
Accident / Damage DMV title problems reported. Damage reported: 02/24/2016 and 11/09/2020. Accident reported: 06/08/2024.	Damage Reported	Damage Reported	Severe Damage
Manufacturer Recall No open recalls reported to CARFAX. Check with an authorized Land Rover dealer for any open recalls.	<input checked="" type="checkbox"/> No Recalls Reported	<input checked="" type="checkbox"/> No Recalls Reported	<input checked="" type="checkbox"/> No Recalls Reported
Basic Warranty Original manufacturer warranty likely voided by manufacturer.	<input checked="" type="checkbox"/> Warranty Active	<input checked="" type="checkbox"/> Warranty Active	Warranty Voided

 Title History	Owner 1	Owner 2	Owner 3
Damage Brands Salvage Junk Rebuilt Fire Flood Hail Lemon	No Problem	No Problem	Alert! Problem Found
Odometer Brands Not Actual Mileage Exceeds Mechanical Limits	No Problem	No Problem	No Problem
 ALERT! - Severe problems were reported by a state Department of Motor Vehicles (DMV). This vehicle does not qualify for the CARFAX Buyback Guarantee.			



 Ownership History	Owner 1	Owner 2	Owner 3
The number of owners is estimated			
Year purchased	2015	2018	2022
Type of owner	Corporate	Personal	Personal
Estimated length of ownership	3 years	3 yrs. 5 mo.	2 yrs. 1 mo.
Owned in the following states/provinces	Rhode Island, Pennsylvania	Pennsylvania, New York	New York
Estimated miles driven per year	11,488/yr	7,448/yr	---
Last reported odometer reading	34,661	60,371	101,600





 Detailed History

**Owner 1**

Purchased: 2015

Corporate
Vehicle
11,488 mi/yr

Date	Mileage	Source	Comments
04/21/2015	10	Land Rover Jaguar Norwood Norwood, MA 781-619-9000 jakekaplans.com/ ★ 4.5 / 5.0 118 Verified Reviews ❤️ 1,902 Customer Favorites	Vehicle offered for sale
05/11/2015		Land Rover Jaguar Norwood Norwood, MA 781-619-9000 jakekaplans.com/ ★ 4.5 / 5.0 118 Verified Reviews ❤️ 1,902 Customer Favorites	 Vehicle serviced - Pre-delivery inspection completed
06/04/2015		Dealer Inventory	Vehicle offered for sale
06/04/2015		Jake Kaplan's Jaguar Land Rover Warwick Warwick, RI 401-461-2000 jakekaplansjaguar.com ★ 4.5 / 5.0 73 Verified Reviews ❤️ 1,130 Customer Favorites	 Vehicle serviced - Vehicle washed/detailed
06/13/2015	68	Jake Kaplan's Jaguar Land Rover Warwick Warwick, RI 401-461-2000 jakekaplansjaguar.com ★ 4.5 / 5.0 73 Verified Reviews ❤️ 1,130 Customer Favorites	Vehicle sold
06/13/2015		Rhode Island Motor Vehicle Dept.	Vehicle purchase reported

06/16/2015	70	Jake Kaplan's Jaguar Land Rover Warwick Warwick, RI 401-461-2000 jakekaplansjaguar.com ★ 4.5 / 5.0 73 Verified Reviews ♥ 1,130 Customer Favorites	 Vehicle serviced - Vehicle washed/detailed
06/17/2015		Rhode Island Motor Vehicle Dept. Garden City, NY	Registration issued or renewed - Titled or registered as corporate vehicle - Vehicle color noted as Blue
07/02/2015	567	Jake Kaplan's Jaguar Land Rover Warwick Warwick, RI 401-461-2000 jakekaplansjaguar.com ★ 4.5 / 5.0 73 Verified Reviews ♥ 1,130 Customer Favorites	 Vehicle serviced - Maintenance inspection completed - Brakes checked - Tire condition and pressure checked
07/14/2015		Rhode Island Motor Vehicle Dept. Fort Worth, TX Title #06969505	Title issued or updated - First owner reported - Registration updated when owner moved the vehicle to a new location
07/16/2015	1,053	Jake Kaplan's Jaguar Land Rover Warwick Warwick, RI 401-461-2000 jakekaplansjaguar.com ★ 4.5 / 5.0 73 Verified Reviews ♥ 1,130 Customer Favorites	 Vehicle serviced - Maintenance inspection completed - Wiper arm/linkage adjusted - Brakes checked - Axle seal(s) replaced - Tire condition and pressure checked
09/21/2015	3,081	Jake Kaplan's Jaguar Land Rover Warwick Warwick, RI 401-461-2000 jakekaplansjaguar.com ★ 4.5 / 5.0 73 Verified Reviews ♥ 1,130 Customer Favorites	 Vehicle serviced - Maintenance inspection completed - Brakes checked - Tire condition and pressure checked
02/24/2016		Damage Report	 Damage reported: minor damage

- Damage to rear



CARFAX HAS THE MOST ACCIDENT & DAMAGE INFORMATION

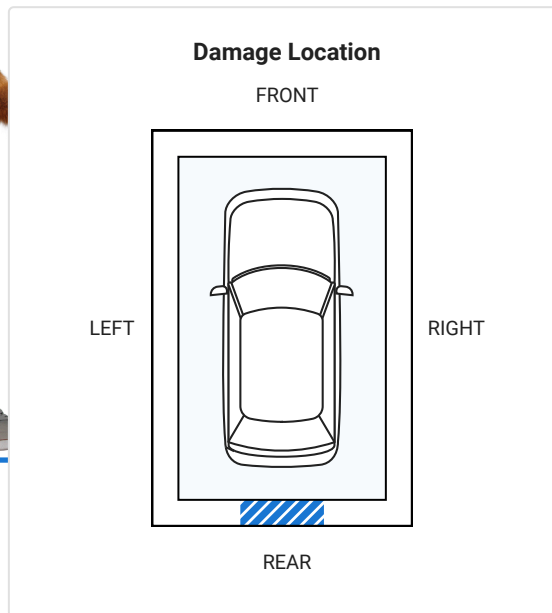
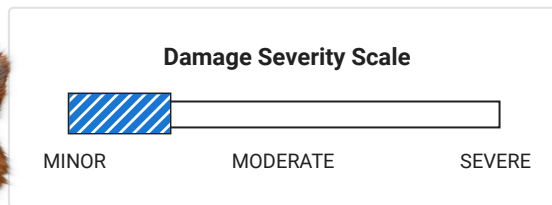

03/31/2016 8,777

Jake Kaplan's Jaguar
Land Rover Warwick
Warwick, RI
401-461-2000
jakekaplansjaguar.com

★ 4.5 / 5.0
73 Verified Reviews
♥ 1,130 Customer Favorites



Vehicle serviced

- Maintenance inspection completed
- 10,000 mile service performed
- Brakes checked
- Tire condition and pressure checked
- Engine/powertrain computer/module reprogrammed

08/03/2016

Rhode Island
Motor Vehicle Dept.
Fort Worth, TX

Registration issued or renewed

- Vehicle color noted as Blue

02/20/2017 19,035

Jake Kaplan's Jaguar
Land Rover Warwick
Warwick, RI
401-461-2000
jakekaplansjaguar.com

★ 4.5 / 5.0
73 Verified Reviews
♥ 1,130 Customer Favorites



Vehicle serviced

- Maintenance inspection completed
- Computer reprogrammed
- Body computer/module reprogrammed
- Oil and filter changed

01/29/2018 28,920

Jake Kaplan's Jaguar
Land Rover Warwick



Vehicle serviced



- Oil and filter changed

Warwick, RI
 401-461-2000
 jakekaplansjaguar.com

★ 4.5 / 5.0
 73 Verified Reviews
 ❤️ 1,130 Customer Favorites

06/18/2018	34,654	Auto Auction	Vehicle sold
06/26/2018		Pennsylvania Motor Vehicle Dept. Duncansville, PA Title #7912631301 BL	Title issued or updated - Dealer took title of this vehicle while it was in inventory
06/29/2018	34,661	Dealer Inventory	Vehicle offered for sale

 **Owner 2** Personal Vehicle
 Purchased: 2018 7,448 mi/yr

Date	Mileage	Source	Comments
07/05/2018	34,675	Pennsylvania Motor Vehicle Dept.	Vehicle purchase reported
08/02/2018		Pennsylvania Motor Vehicle Dept. Butler, PA Title #7912631302 PO	Title issued or updated - New owner reported - Loan or lien reported
02/26/2019		Pennsylvania Motor Vehicle Dept. Butler, PA Title #7912631302 PO	Registration issued or renewed
02/13/2020	49,814	Bobby Rahal Volvo Jaguar Land Rover Wexford, PA 724-940-3500 bobbyrahal.com/ ★ 4.6 / 5.0 162 Verified Reviews ❤️ 124 Customer Favorites	 Vehicle serviced - Maintenance inspection completed - Engine replaced
03/10/2020		Pennsylvania Motor Vehicle Dept. Butler, PA Title #7912631302 PO	Registration issued or renewed
11/09/2020		Damage Report	 Damage reported: minor damage - Damage to front



CARFAX HAS THE MOST ACCIDENT & DAMAGE INFORMATION

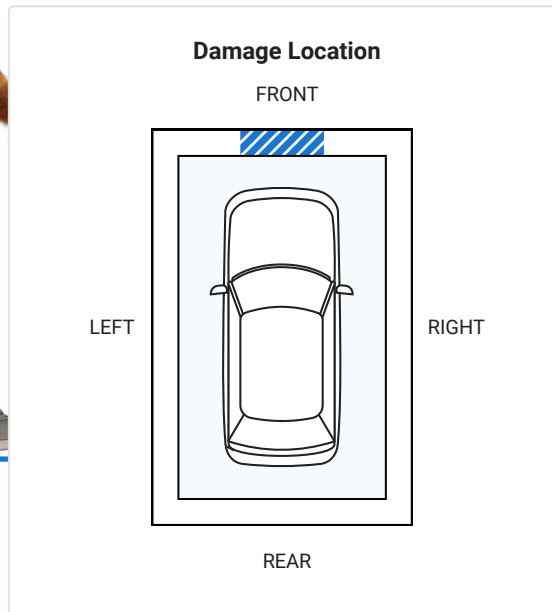
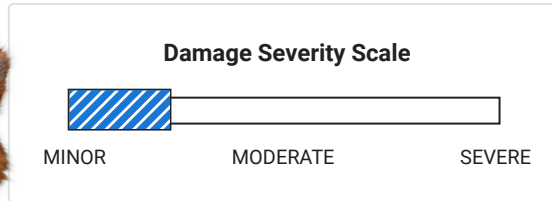

11/27/2020 53,633

Diehl Chrysler Jeep
Dodge VW
Butler, PA
724-282-8898
diehlauto.com

★ 4.4 / 5.0

86 Verified Reviews

♥ 94 Customer Favorites



Vehicle serviced

- A/C refrigerant recharged

01/12/2021 54,505

Bobby Rahal Volvo
Jaguar Land Rover
Wexford, PA
724-940-3500
bobbyrahal.com/

★ 4.6 / 5.0

162 Verified Reviews

♥ 124 Customer Favorites



Vehicle serviced

- Maintenance inspection completed

- Battery replaced

- Electrical system checked

06/22/2021

Pennsylvania
Motor Vehicle Dept.
Butler, PA
Title #7912631302 PO

Registration issued or renewed

10/28/2021

Bobby Rahal Volvo
Jaguar Land Rover
Wexford, PA
724-940-3500



Vehicle serviced





- Engine/powertrain computer/module checked

bobbyrahal.com/

★ 4.6 / 5.0

162 Verified Reviews

♥ 124 Customer Favorites

12/13/2021	60,328	Auto Auction	Listed as a dealer vehicle - Vehicle sold
01/14/2022		Marina Mitsubishi Webster, NY 585-699-1569 marinamitsubishi.com/	 Vehicle serviced - Pre-delivery inspection completed
02/11/2022		New York Inspection Station	Passed safety inspection - Passed emissions inspection
02/14/2022	60,330	Marina Mitsubishi Webster, NY 585-699-1569 marinamitsubishi.com/	 Vehicle serviced - Oil and filter changed - Rear brake pads replaced - Rear brake rotor(s) replaced - Brake pads replaced - Battery/charging system checked - Emissions inspection performed
04/01/2022	60,363	Marina Mitsubishi Webster, NY 585-699-1569 marinamitsubishi.com/	 Vehicle serviced - Vehicle washed/detailed - Emissions inspection performed
04/02/2022	60,371	New York Inspection Station	Passed safety inspection - Passed emissions inspection
04/02/2022		New York Motor Vehicle Dept. Rochester, NY	Registration issued or renewed - Titled or registered as personal vehicle - Passed safety inspection
04/10/2022		Marina Mitsubishi Webster, NY 585-699-1569 marinamitsubishi.com/	 Vehicle serviced



Owner 3

Purchased: 2022

Personal Vehicle

Date	Mileage	Source	Comments
06/07/2022		New York Motor Vehicle Dept. Rochester, NY	Title issued or updated - New owner reported - Loan or lien reported
04/09/2024	101,600	New York	Passed safety inspection

	Inspection Station	- Passed emissions inspection
04/09/2024	New York Motor Vehicle Dept. Rochester, NY	Registration issued or renewed - Titled or registered as personal vehicle - Passed safety inspection
06/08/2024	Damage Report	 Accident reported: minor damage with another motor vehicle - Damage to left rear - Damage to left side



CARFAX HAS THE MOST ACCIDENT & DAMAGE INFORMATION

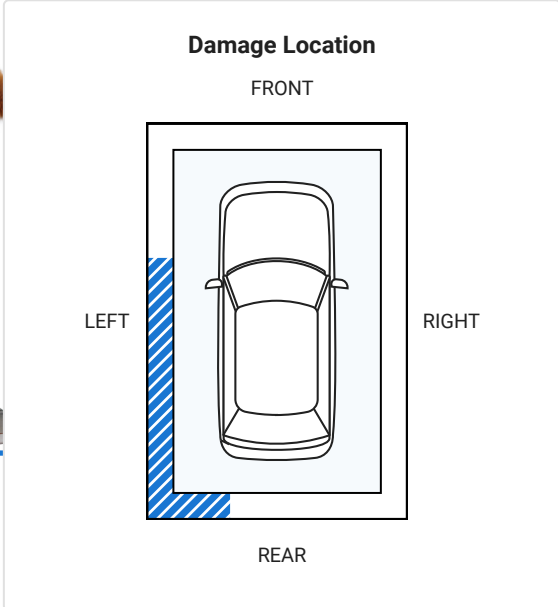
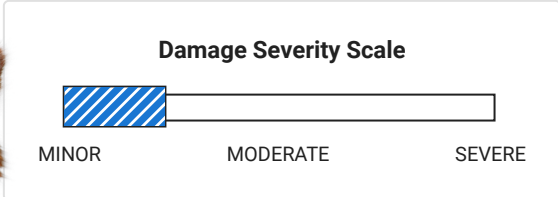

07/17/2024	Damage Report	 SALVAGE TITLE/CERTIFICATE ISSUED
------------	---------------	-----------------------------------------------------------------------------------------------------------------------------

Have Questions? Consumers, please visit our Help Center at www.carfax.com. Dealers or Subscribers, please visit our Help Center at www.covin.top/carfax.

Follow Us:  facebook.com/CARFAX [@CARFAXinc](https://twitter.com/CARFAXinc)  About CARFAX

CARFAX DEPENDS ON ITS SOURCES FOR THE ACCURACY AND RELIABILITY OF ITS INFORMATION. THEREFORE, NO RESPONSIBILITY IS ASSUMED BY CARFAX OR ITS AGENTS FOR ERRORS OR OMISSIONS IN THIS REPORT. CARFAX FURTHER EXPRESSLY DISCLAIMS ALL WARRANTIES, EXPRESS OR IMPLIED, INCLUDING ANY IMPLIED WARRANTIES OF MERCHANTABILITY OR FITNESS FOR A PARTICULAR PURPOSE.

© 2024 CARFAX, Inc., part of S&P Global. All rights reserved.
7/24/24 11:49:09 AM (CDT)

I have reviewed and received a copy of the CARFAX Vehicle History Report for this 2015 LAND ROVER RANGE ROVER EVOQUE vehicle (VIN: SALVP2BG7FH053269), which is based on information supplied to CARFAX and available as of 7/24/24 at 12:49 PM (EDT).

Customer Signature

Date

Dealer Signature

Date