



Vehicle History Report™

2013 MAZDA CX-9 TOURING

VIN: JM3TB3CA8D0414850
4 DOOR WAGON/SPORT
UTILITY
3.7L V6 F DOHC 24V
GASOLINE
ALL WHEEL DRIVE

Damage reported

10 Service history records

3 Previous owners

Types of owners: Personal lease, Personal

Last owned in Illinois

141,000 Last reported odometer reading

This CARFAX Vehicle History Report is based only on information supplied to CARFAX and available as of 3/6/24 at 11:53:50 AM (CST). Other information about this vehicle, including problems, may not have been reported to CARFAX. Use this report as one important tool, along with a vehicle inspection and test drive, to make a better decision about your next used car.



Ownership History

The number of owners is estimated

	Owner 1	Owner 2	Owner 3
Year purchased	2013	2016	2021
Type of owner	Personal lease	Personal	Personal
Estimated length of ownership	2 yrs. 10 mo.	4 yrs. 10 mo.	3 years
Owned in the following states/provinces	Illinois	Illinois	Illinois
Estimated miles driven per year	6,362/yr	22,676/yr	---
Last reported odometer reading	18,094	101,000	141,000



Title History

CARFAX guarantees the information in this section

	Owner 1	Owner 2	Owner 3
Damage Brands Salvage Junk Rebuilt Fire Flood Hail Lemon	Guaranteed No Problem	Guaranteed No Problem	Guaranteed No Problem
Odometer Brands Not Actual Mileage Exceeds Mechanical Limits	Guaranteed No Problem	Guaranteed No Problem	Guaranteed No Problem







GUARANTEED - None of these title problems were reported by a U.S. state Department of Motor Vehicles (DMV). If you find that any of these title problems were reported by a DMV and not included in this report, you may qualify.
View Terms | View Certificate

CARFAX Additional History Not all accidents / issues are reported to CARFAX	Owner 1	Owner 2	Owner 3
Total Loss No total loss reported to CARFAX.	✔ No Issues Reported	✔ No Issues Reported	✔ No Issues Reported
Structural Damage CARFAX recommends that you have this vehicle inspected by a collision repair specialist.	✔ No Issues Reported	✔ No Issues Reported	✔ No Issues Reported
Airbag Deployment No airbag deployment reported to CARFAX.	✔ No Issues Reported	✔ No Issues Reported	✔ No Issues Reported
Odometer Check No indication of an odometer rollback.	✔ No Issues Indicated	✔ No Issues Indicated	✔ No Issues Indicated
Accident / Damage Damage reported: 07/15/2020 and 02/21/2024.	✔ No Issues Reported	Damage Reported	Damage Reported
Manufacturer Recall Check with an authorized Mazda dealer for any open recalls.	✔ No Recalls Reported	✔ No Recalls Reported	✔ No Recalls Reported
Basic Warranty Original warranty estimated to have expired.	Warranty Expired	Warranty Expired	Warranty Expired

CARFAX Detailed History

Owner 1 Purchased: 2013 	<div style="border: 1px solid #00aaff; padding: 5px; display: inline-block;"> Low mileage! This owner drove less than the industry average of 15,000 miles per year. </div>	Personal Lease Vehicle 6,362 mi/yr	
Date	Mileage	Source	Comments
03/11/2013		NICB	Vehicle manufactured and shipped to original dealer
04/15/2013	12	Pugi Mazda Downers Grove, IL 630-964-9500 pugi.com ★ 4.6 / 5.0 399 Verified Reviews	Vehicle offered for sale
04/16/2013		Illinois	Vehicle purchase reported

		Motor Vehicle Dept.		- Titled or registered as personal lease vehicle
04/23/2013	42	Castle Volkswagen Downers Grove, IL 630-964-9500 castlevwdownersgrove.com/ ★ 4.3 / 5.0 50 Verified Reviews ♥ 181 Customer Favorites		Vehicle serviced - Pre-delivery inspection completed - Maintenance inspection completed
05/01/2013		Illinois Motor Vehicle Dept. Plainfield, IL Title #X3121690294		Title issued or updated - Registration issued or renewed - First owner reported - Loan or lien reported - Vehicle color noted as Gray
09/07/2013	2,420	Castle Volkswagen Downers Grove, IL 630-964-9500 castlevwdownersgrove.com/ ★ 4.3 / 5.0 50 Verified Reviews ♥ 181 Customer Favorites		Vehicle serviced - Oil and filter changed - Battery/charging system checked - Brakes checked - Tire condition and pressure checked
02/24/2014		Illinois Motor Vehicle Dept. Plainfield, IL		Registration issued or renewed
08/06/2014	6,428	Castle Volkswagen Downers Grove, IL 630-964-9500 castlevwdownersgrove.com/ ★ 4.3 / 5.0 50 Verified Reviews ♥ 181 Customer Favorites		Vehicle serviced - Maintenance inspection completed - Battery/charging system checked - Brakes checked - GPS/Navigation module/computer reprogrammed - Oil and filter changed - Tire condition and pressure checked
01/21/2015		Illinois Motor Vehicle Dept. Plainfield, IL		Registration issued or renewed
09/12/2015	14,710	Castle Volkswagen Downers Grove, IL 630-964-9500 castlevwdownersgrove.com/ ★ 4.3 / 5.0 50 Verified Reviews ♥ 181 Customer Favorites		Vehicle serviced - Maintenance inspection completed - 5,000 mile service performed - Battery/charging system checked - Brakes checked - Fluids checked - Tire repaired - Anti-theft/keyless remote battery replaced

- Tire condition and pressure checked



01/29/2016		Illinois Motor Vehicle Dept. Plainfield, IL	Registration issued or renewed
02/16/2016		Pugi Mazda Downers Grove, IL 630-964-9500 pugi.com ★ 4.6 / 5.0 399 Verified Reviews	Vehicle sold
02/16/2016		Illinois Motor Vehicle Dept.	Vehicle purchase reported
02/18/2016	18,094	Pugi Mazda Downers Grove, IL 630-964-9500 pugi.com ★ 4.6 / 5.0 399 Verified Reviews	Vehicle offered for sale
03/02/2016		Illinois Motor Vehicle Dept. Winfield, IL	Registration issued or renewed









Owner 2

Purchased: 2016

Personal Vehicle
22,676 mi/yr

Date	Mileage	Source	Comments
03/03/2016	18,123	Illinois Motor Vehicle Dept. Winfield, IL Title #160636947010	Title issued or updated - New owner reported - Loan or lien reported - Vehicle color noted as Gray
06/21/2016	27,428	Castle Volkswagen Downers Grove, IL 630-964-9500 castlevwdownersgrove.com/ ★ 4.3 / 5.0 50 Verified Reviews ❤️ 181 Customer Favorites	 Vehicle serviced - Maintenance inspection completed - 5,000 mile service performed - Brakes checked - Fluids checked - Tire pressure sensor reprogrammed - Tire pressure monitoring system reset - Tire condition and pressure checked
11/01/2016	32,724	BARTELS AUTO CLINIC Carol Stream Carol Stream, IL 630-653-2336 bartelsautoclinics.com/ ★ 4.7 / 5.0 98 Verified Reviews	 Vehicle serviced - Oil and filter changed - Cabin air filter replaced/cleaned - Air filter replaced

 **899** Customer Favorites

12/19/2016		Illinois Motor Vehicle Dept. Winfield, IL		Registration issued or renewed
11/29/2017		Illinois Motor Vehicle Dept. Winfield, IL		Registration issued or renewed
01/24/2018		Illinois Motor Vehicle Dept. Winfield, IL		Registration issued or renewed
06/29/2018	72,131	Castle Volkswagen Downers Grove, IL 630-964-9500 castlevwdownersgrove.com/ ★ 4.3 / 5.0 50 Verified Reviews  181 Customer Favorites		Vehicle serviced - Maintenance inspection completed - Battery/charging system checked - Brakes checked - Tire condition and pressure checked
08/29/2018	75,288	Castle Volkswagen Downers Grove, IL 630-964-9500 castlevwdownersgrove.com/ ★ 4.3 / 5.0 50 Verified Reviews  181 Customer Favorites		Vehicle serviced - Maintenance inspection completed - One tire mounted - Tire(s) mounted - One tire replaced - Tire(s) replaced
11/27/2018		Illinois Motor Vehicle Dept. Winfield, IL		Registration issued or renewed
12/20/2018	82,104	Castle Volkswagen Downers Grove, IL 630-964-9500 castlevwdownersgrove.com/ ★ 4.3 / 5.0 50 Verified Reviews  181 Customer Favorites		Vehicle serviced - Maintenance inspection completed - Battery/charging system checked - Brakes serviced - Front brake pads replaced - Wiper(s) replaced - Tire condition and pressure checked
10/28/2019	101,000	Illinois Inspection Station Addison, IL		Passed emissions inspection
10/30/2019		Illinois Motor Vehicle Dept. Winfield, IL		Registration issued or renewed

07/15/2020

Damage Report



Damage reported: minor damage
- Damage to front



CARFAX HAS THE MOST ACCIDENT & DAMAGE INFORMATION

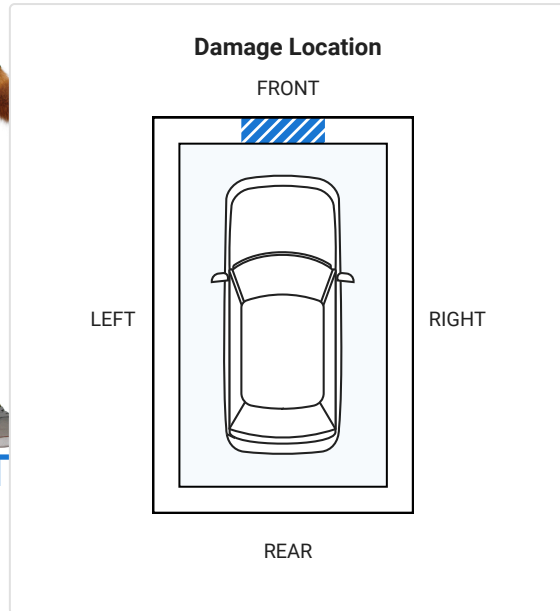
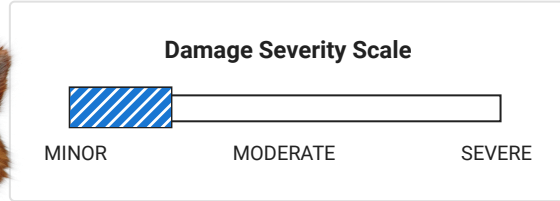

10/08/2020

Illinois
Motor Vehicle Dept.
Winfield, IL

Registration issued or renewed

01/03/2021

Illinois
Motor Vehicle Dept.

Vehicle purchase reported

01/05/2021

Illinois
Motor Vehicle Dept.
Burbank, IL

Registration issued or renewed

Owner 3
Purchased: 2021

Personal Vehicle

Date	Mileage	Source	Comments
02/02/2021		Illinois Motor Vehicle Dept. Burbank, IL Title #210336921670	Title issued or updated - New owner reported - Vehicle color noted as Gray
12/07/2021		A&M Car Care Bridgeview, IL 708-907-5049 10 Customer Favorites	Vehicle serviced

01/14/2022	Illinois Inspection Station Chicago, IL	Passed emissions inspection
02/28/2022	Illinois Motor Vehicle Dept. Burbank, IL	Registration issued or renewed
02/02/2023 141,000	Illinois Inspection Station Chicago, IL	Passed emissions inspection
02/07/2023	Illinois Motor Vehicle Dept. Burbank, IL	Registration issued or renewed
02/21/2024	Damage Report	 Damage reported - Damage to left front

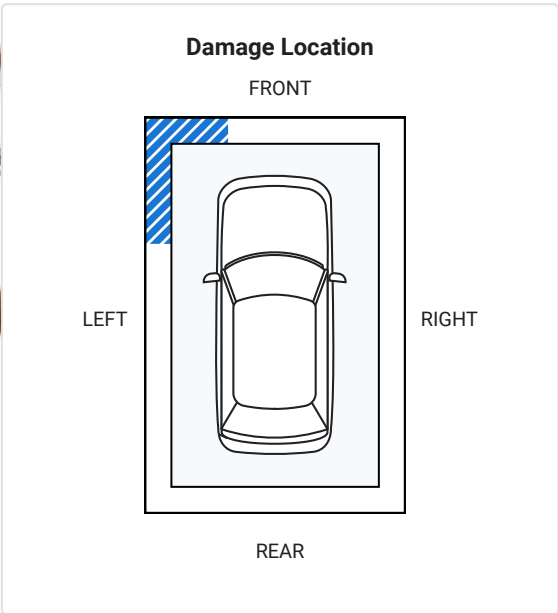

CARFAX HAS THE MOST ACCIDENT & DAMAGE INFORMATION



Not all damage is caused by an accident. Get the car inspected before you buy. [Learn More](#)

Have Questions? Consumers, please visit our Help Center at www.carfax.com. Dealers or Subscribers, please visit our Help Center at www.carfaxonline.com.



Glossary

Damage Indicator

Damage can be a result of many different types of events. Examples include contact with objects (other cars, trees, traffic signs, road debris, etc), vandalism, or weather-related events. Not every damage event is reported to CARFAX. As details about the damage event become available, those additional details are added to the CARFAX Vehicle History Report. CARFAX recommends that you have this vehicle inspected by a qualified mechanic.

- This CARFAX Vehicle History Report is based only on information supplied to CARFAX and available as of 3/6/24 at 11:53:50 AM (CST). Other information about this vehicle, including problems, may not have been reported to CARFAX. Use this report as one important tool, along with a vehicle inspection and test drive, to make a better decision about your next used car.

Damage Severity

Damage events result in one of the following severity levels:

- Minor: Generally, minor damage is cosmetic (including dents or scratches), may only require reconditioning, and typically does not compromise a vehicle's operation and/or safety.
- Moderate: Moderate damage may affect multiple components of the vehicle and may impair the vehicle's operation and/or safety.
- Severe: Severe damage usually affects multiple components of the vehicle and is likely to compromise the vehicle's operation and/or safety.

CARFAX recommends getting a pre-purchase inspection at a certified collision repair facility.

First Owner

When the first owner(s) obtains a title from a Department of Motor Vehicles as proof of ownership.

New Owner Reported

When a vehicle is sold to a new owner, the Title must be transferred to the new owner(s) at a Department of Motor Vehicles.

Ownership History

CARFAX defines an owner as an individual or business that possesses and uses a vehicle. Not all title transactions represent changes in ownership. To provide estimated number of owners, CARFAX proprietary technology analyzes all the events in a vehicle history. Estimated ownership is available for vehicles manufactured after 1991 and titled solely in the US including Puerto Rico. Dealers sometimes opt to take ownership of a vehicle and are required to in the following states: Maine, Massachusetts, New Jersey, Ohio, Oklahoma, Pennsylvania and South Dakota. Please consider this as you review a vehicle's estimated ownership history.

Title Issued

A state issues a title to provide a vehicle owner with proof of ownership. Each title has a unique number. Each title or registration record on a CARFAX report does not necessarily indicate a change in ownership. In Canada, a registration and bill of sale are used as proof of ownership.

Follow Us:



[facebook.com/CARFAX](https://www.facebook.com/CARFAX)

@CARFAXinc



About CARFAX

CARFAX DEPENDS ON ITS SOURCES FOR THE ACCURACY AND RELIABILITY OF ITS INFORMATION. THEREFORE, NO RESPONSIBILITY IS ASSUMED BY CARFAX OR ITS AGENTS FOR ERRORS OR OMISSIONS IN THIS REPORT. CARFAX FURTHER EXPRESSLY DISCLAIMS ALL WARRANTIES, EXPRESS OR IMPLIED, INCLUDING ANY IMPLIED WARRANTIES OF MERCHANTABILITY OR FITNESS FOR A PARTICULAR PURPOSE.

© 2024 CARFAX, Inc., part of S&P Global. All rights reserved.
3/6/24 11:53:50 AM (CST)

I have reviewed and received a copy of the CARFAX Vehicle History Report for this 2013 MAZDA CX-9 vehicle (VIN: JM3TB3CA8D0414850), which is based on information supplied to CARFAX and available as of 3/6/24 at 12:53 PM (EST).

Customer Signature

Date

Dealer Signature

Date